

# Instructions for start-up, operation and maintenance

**one2clean plus**  
**one2clean plus XXL**

**Small wastewater treatment  
systems**

**Control unit version KL24plus**



The points described in these instructions must be observed in all cases. Failure to do so shall invalidate the warranty. For any additional items purchased through GRAF, you will receive separate installation instructions in the transport packaging.

The components must be checked for any damage before the system is transferred to the pit.

You will receive separate instructions for installation of the system.

**Be sure to read before starting up!**

## Contents

1. General information	2
2. Safety	3
3. Description of function	6
4. Control unit	8
5. Start-up	18
6. Level measurement	19
7. Operation and maintenance	22
8. Fault messages and rectification	28
9. EC conformity declaration	31
10. Technical data	32
11. Template for weekly / monthly check notes	34
12. Maintenance log for GRAF small wastewater treatment systems	37
13. Notes	39

# 1. General information

## 1. General information

Below you will find some important information for safely operating your system for a long time to come.

- The SBR system is designed to receive all domestic wastewater. Other wastewater, e.g. from restaurants and / or commercial premises etc., may only be received if this was specified and taken into account in the system's design.
- Biocides, toxic substances or substances which are not biocompatible must not enter this system because they hinder bacteria important to wastewater cleaning and cause problems in the biological process (detailed information is provided on the following pages).

**To meet official cleaning requirements, it is essential that the system is operated in accordance with our operating and maintenance instructions. You will find these instructions on the following pages.**

We also ask you to read the following information carefully:

- The External control cabinets should be located as much in the shade as possible to prevent them from overheating in the summer.
- At all times ensure that the cabinet, especially its ventilation apertures, are not covered and are freely accessible for maintenance work.
  - ▶ External control cabinet: Ventilation apertures on the rear
- The power supply must be ensured at all times. Please ensure that the fuse on the control cabinet is sufficient (16 A). Additional electrical fixtures on the same fuse may disrupt operation.

## 2. Safety

### 2. Safety

This chapter contains details relating to safety measures and residual risks. Read this chapter through carefully before using the system to ensure that it is used as safely as possible.

#### 2.1 Intended use

The control unit was specifically developed for use in SBR small wastewater treatment systems. The control unit must not be used in areas representing a danger to life and limb:

- control of machinery, vehicles and safety processes,
- research technology involving hazardous substances,
- medical technology,
- nuclear power technology,
- etc.

#### 2.2 Explanation of warning notices and prohibitions



Warning of danger



Warning of dangerous voltage



Warning of tripping risk



Warning of hot surface



Warning of hand injuries



Warning of explosive atmospheres



Fire, naked flames and smoking prohibited

## 2. Safety

### 2.3 Danger notices

1. To ensure safety, everyone who comes into direct contact with the system must note the content of this documentation.
2. The system must not be used for any purpose other than that described by the manufacturer.
3. Local operating and safety requirements and legislation must be followed at all times, even if they are not explicitly mentioned in these instructions. The same applies to environmental requirements.
4. If the operator becomes aware of mistakes or dangers, the manufacturer or responsible maintenance company must be informed immediately.
5. Safety precautions must never be removed or bypassed during normal operation of the wastewater treatment system. Safety precautions may only be temporarily bypassed or deactivated by the maintenance fitter during repairs and maintenance.
6. When working with chemical substances, contact with the chemicals should be avoided. Before these substances may be used, the instructions for use on the packaging must be read and followed.
7. If the use of personal protective equipment (safety shoes, protective glasses, gloves, ear defenders, etc.) is prescribed, ensure that they are used. Defective or damaged protective equipment must be immediately replaced with fully functional equipment.
8. Work on electrical equipment may only be undertaken by specialists.
9. All safety and danger notices on the machine should always be kept fully legible.
10. Hot parts must not come into contact with explosive or highly flammable chemicals.
11. Do not put vessels containing liquids on electric switch cabinets; short circuits may occur if the liquid is spilled.
12. The system must not be operated by anyone under the influence of alcohol or medication which limits cognitive ability or ability to react.
13. The system must be de-energised before any maintenance or cleaning work takes place.
14. Other than for maintenance purposes, the system should always be left switched on, otherwise correct wastewater cleaning cannot be guaranteed.

## 2. Safety

### 2.4 Warning notices

Be sure to observe this information. Failure to do so may result in personal injury or damage to property!



Installation location

Ensure that the machine cabinet is not installed above or in the direct vicinity of water vessels. There is a risk of electric shock if improperly installed.



Mains connection

Only connect the machine cabinet to a correctly installed 230 V socket or earth cable which is fused with an upstream 16 A fuse.

Electrical equipment connected to the mains may be damaged during a storm. We would recommend fitting surge protection in the building to protect against this. The connection cable must be laid in a way it won't represent a tripping hazard.



Explosive atmospheres

The control unit must not be fitted or activated in environments with potential explosive atmospheres or in places where there are flammable materials. Sparks in such environments may cause an explosion or fire and this may result in physical injuries or even death.



Interferences

The control unit may cause medical equipment to malfunction. This device should therefore not be used in close proximity to medical equipment.



Damage

The control unit must not be operated if the housing or cable insulation is damaged or crushed.



Service work

Service work on the machine cabinet may only be undertaken by authorised specialists / electricians.



Voltage supply

The power supply must be ensured at all times. Please ensure that the fuse on the control cabinet is sufficient (16 A). Additional electrical fixtures on the same fuse may disrupt operation.

## 3. Description of function

### 3. Description of function

#### 3.1 Description of the wastewater treatment process

The one2clean plus wastewater treatment system is a fully biological system and functions on the principle of the retention process with extended aeration (Sequencing Batch Reactor). The system basically consists of an aerobic stage, which is split into a rest and an aeration zone, linked together in the lower section. This process therefore subjects all the domestic wastewater directly to aerobic wastewater treatment. Blowing in compressed air aerates the entire system and the resultant aerated sludge biologically cleans the wastewater.

The coarse materials and floating solids in the wastewater are initially retained using a scum guard in the rest zone. Then the wastewater passes into the aeration zone via an aperture under the scum guard.

The rest zone is aerated too, so the retained solids are also aerobically broken down over the course of time. In the one2clean plus, the wastewater is treated without pre-treatment so no anaerobic putrefaction processes can occur.

The SBR procedure is a series of different steps, undertaken one after another and at least once a day.

##### Step 1: Aeration

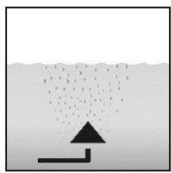

In the first phase, the wastewater is put straight through aerobic treatment for a fixed time. As a result, the microorganisms (aerated sludge) are supplied with the oxygen needed for the breakdown and then pressure aeration causes mixing. The system's aeration equipment is supplied with ambient air by a compressor. Aeration is intermittent so that targeted wastewater cleaning is possible. Different ambient conditions can thereby be achieved.

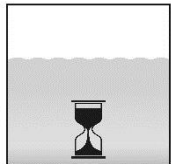

##### Step 2: Settle

There is no aeration in the second phase. The aerated sludge and the remaining settleable solids can now settle with the aid of gravity. A clear water zone forms at the top and a sludge layer at the bottom. Any floating sludge is on top of the clear water zone.

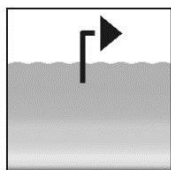

##### Step 3: Clear water extraction

In this phase, the biologically cleaned wastewater (clear water) is drawn out of the SBR stage. It is pumped out by an air lift (or mammoth) pump, which uses compressed air. The air lift pump is designed not to pump out any floating sludge on top of the clear water layer. A minimum water level is maintained in the system without any further components.

In multi-tank systems, there is also a phase in which the sludge is returned to the system.

Once step is complete, the cleaning process starts again with step 1.

Two cycles are undertaken a day. The maintenance company can individually adapt the switching times.

### 3. Description of function

#### 3.2 Structure of one-tank systems

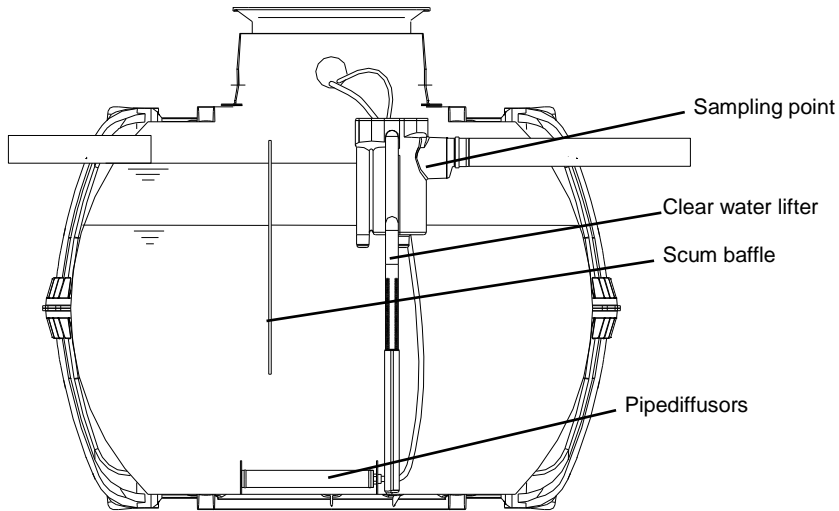

Figure 1: One-tank system

#### 3.3 Structure of multi-tank systems

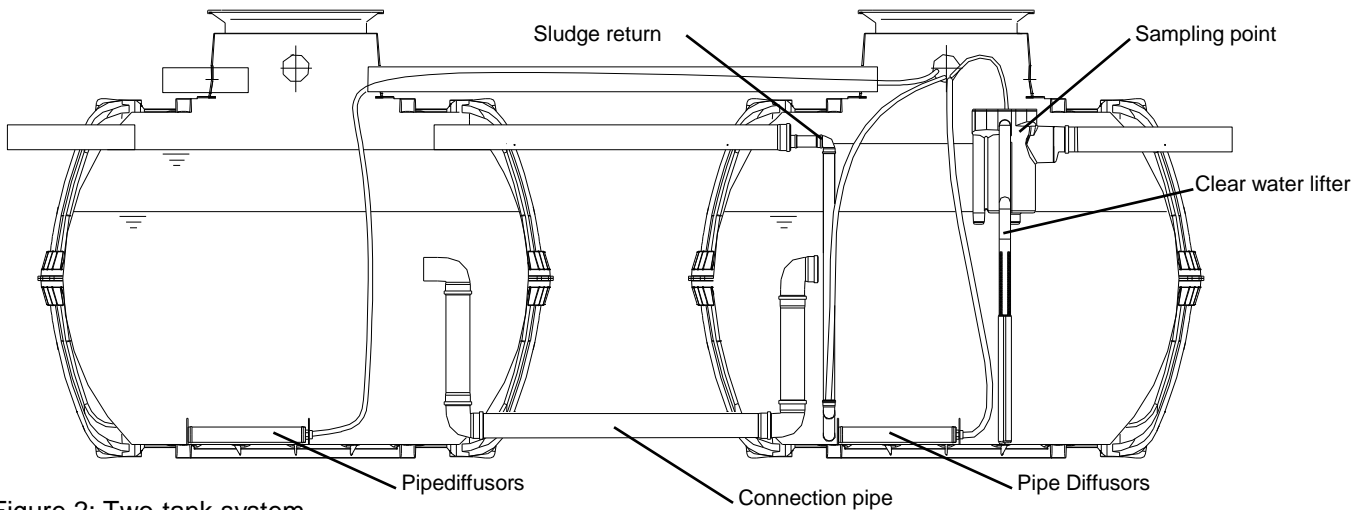

Figure 2: Two-tank system

## 4. Control unit

### 4. Control unit

#### 4.1 Connections to the KL24plus control unit

The figures below show the basic structure of the switch cabinet of a two-tank system.

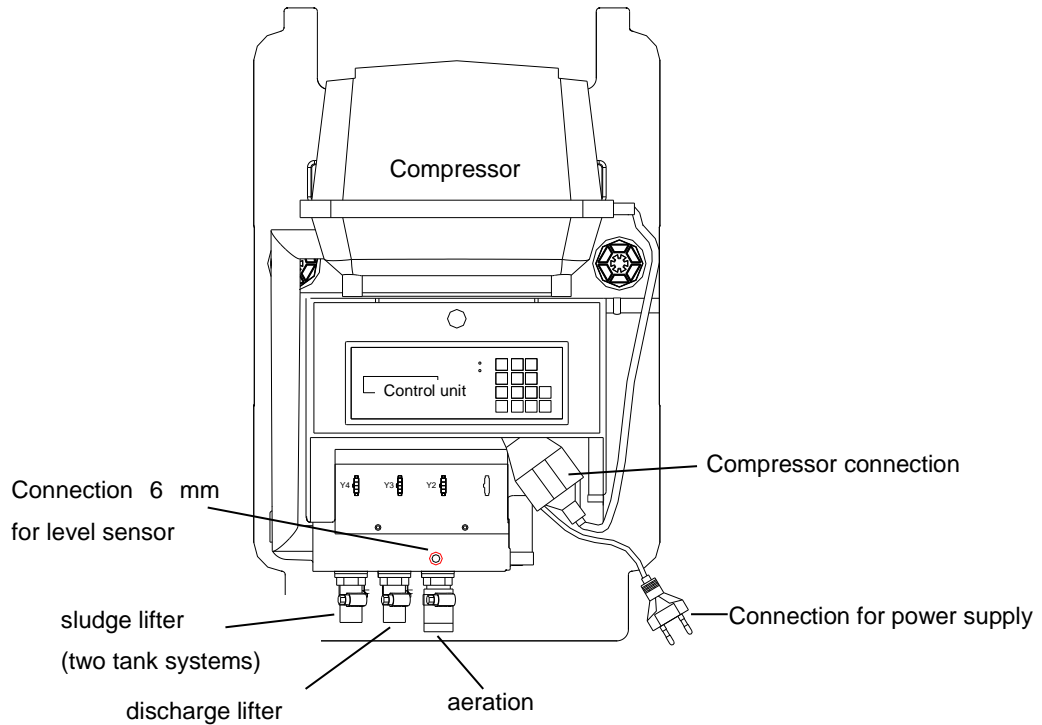

Figure 3: EPP cabinet with 3-way air distributor

The following connections can be found on the switch cabinet:

1. 230V AV ~ 50 Hz mains connection, for connecting the control unit to a socket
2. Compressor connection, for connecting the compressor to the control unit via an integrated two pin plug
3. Compressor's air connection. This is used to connect the strip of valves integrated in the switch box to the compressor
4. Hose connection (19 mm) for connecting the aeration unit
5. Hose connection (13 mm) for connecting the discharge lifter
6. Hose connection (13 mm) for connecting the sludge lifter
7. One unused hose connection

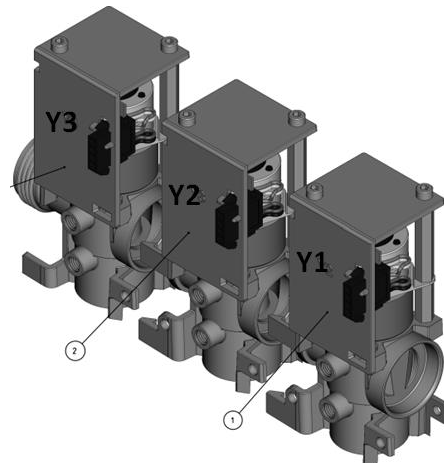

Figure 4: Air distributor with stepped motors



## 4. Control unit

### 4.2 Connections on the rear of the control unit

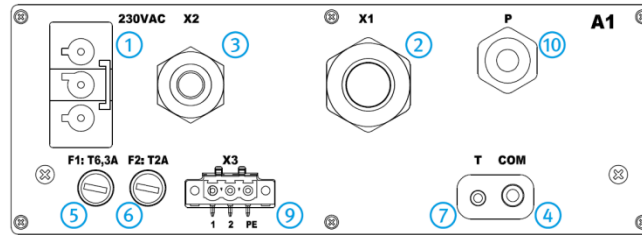

Figure 5: Rear of KL24plus control unit

#### Connections:

- 1 Connection for mains cable  
230 V AC ~ 50 Hz
- 2 X1: Pre-assembled valve cable
- 3 X2: two pin plugs for the air compressor connection
- 4 COM: Connection for communication module (optional) and/or port for PC
- 5 F1: T6.3A main fuse, slow blow
- 6 F2: T2A fuse for UV module, slow blow
- 7 Connection for temperature sensor, "must be plugged in!"
- 9 X3: Connection for UV module
- 10 P: Connection for pressure measuring hose

### 4.3 Connections on the air distributor/valve block

When delivered, the control unit is already correctly connected to the corresponding connection on the air distributor/valve block.

A distinction is made between two different air distributor variants:

1. 3-way air distributor (3 separate valves Y2 ... Y4) and
2. 2-way air distributor (2 separate valves Y3 and Y4)

To allow you to correctly connect up at a later date, the connectors of the control unit (X1.1 ... X1.4), their function (aeration, clear water extraction or sludge extraction) and the connections on the air distributor in a matrix are shown in detail in the table below.

Control unit			Air distributor connections				
Functions	Valves	Connectors	3-way			2-way	
			Y3	Y2	Y1	Y2	Y1
Aeration	Valve 1	X1.1			blue		blue
Clear water extraction	Valve 2	X1.2		black.		black.	
Sludge return	Valve 3	X1.3	white				

## 4. Control unit

### 4.4 Starting up the control unit

Once the system has been connected to the power supply, perform a brief system test. The system test takes a few seconds and checks the real-time buffering. During this time, the LED lights up red. Then the LED switches to green and the start phase is complete. During the system test the words "SYSTEM TEST ... OK" appear. The program version and the control unit's serial number are displayed briefly. The system's current operating mode is then displayed in the liquid crystal display. Once the system test is complete, the date and current time should be checked and adjusted if necessary.

After checking the date/time, the function of the installed parts should be checked. The check can only take place as soon as the installed parts are connected to the control cabinet via the air hoses needed. The check should be carried out via the "Manual operation" menu item in the control unit. The individual installed parts should be activated and checked in turn.

The system should be reset to automatic mode once the check is completed successfully.





**PLEASE NOTE:** The clear water lifter will only work if the tanks are filled.

If the time and date are not set correctly, operating faults are saved with the wrong times.

## 4. Control unit

### 4.5 Instructions for operating the wastewater treatment system

The system is operated using a microprocessor in the control unit. The microprocessor allows operating parameters to be set, operating statuses to be displayed, system parameters to be queried and operating times to be programmed by a specialist.

Settings are entered by scrolling through numerical values using the   and   arrow keys.

The setting is then confirmed by pressing the  key.

The individual dialogues can be closed prematurely by pressing  or close automatically after **2 minutes**.

The control unit is divided into the following display screens:

1. Basic level: Status of cycle process with remaining time elapsing and fault message display.
2. Operator level: By pressing the  key, the operator can enter the operator level and undertake operator-specific settings.
3. Service level: A password-protected service level is accessed from the operator level via an additional code. This level is reserved for trained staff. Settings and/or changes can be undertaken here and diagnosis data called up.

#### 4.5.1 Control programs

The control unit switches the outputs for air compressors and valves at specific times.

The times are defined by the set sequence tables.

In accordance with the sequence table selected, a complete cleaning cycle is started at each start time.

Setting holiday times at operator level enables all cleaning cycles to be suppressed for the set time period. Only a holiday cycle with greatly reduced activity occurs during this time. No treated wastewater is extracted during this time because no water should be fed in.

The current sequence table can be modified by trained staff in the service level. Depending on the size of the wastewater treatment system, another sequence table can be selected. The current sequence table and other settings are stored resistant to zero voltage. The current sequence table is only modified or a new sequence table selected in the cycle pause. This ensures that the current extraction is always undertaken at the end of a complete cleaning cycle.

If this is not necessary, the user can perform a "Cycle restart" to immediately adopt the modified parameters.

A sequence table consists of:

- table name - comprising max. 16 characters, e.g. **one2clean plus 4PE C**
- number of start times (cycles) - max. 24
- cycles - with cycle times and the consumers to be switched

## 4. Control unit

### 4.5.2 Operating status display

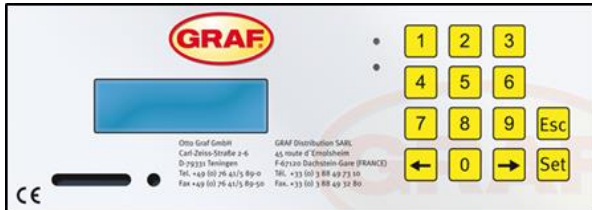

Figure 6 View of KL24plus operating unit

The system's operating status is indicated by the LEDs (**Green** = Operation / **Red** = Fault) and by text on the screen.

In normal operating mode (aeration mode), the display looks like this:

Aeration  
Remaining:  
120:10min

In automatic mode, the liquid crystal display shows the current operating phase and time remaining in this stage of operation.

If a fault occurs, the red LED switches on. A message appears in the liquid crystal display indicating which component is faulty (e.g. compressor 0.0A fault).

The following operating phases are displayed:

KL24plus Control unit	Process undertaken
Denitrification	Aeration is activated intermittently, the aerated sludge is briefly mixed. There are long pauses in between (reaction times).
Aeration	Aeration is activated, the system is aerated at intervals.
Settling phase	Rest phase; the aerated sludge settles.
Discharge phase	Discharge lifter is activated, the clear water is pumped into the discharge.
Sludge removal	Sludge lifter is activated, the excess sludge is pumped out of the last tank back into the first one. <b>ONLY with multi-tank systems</b>
Cycle pause	Aeration is activated, the system is aerated at intervals (considerably less than in the "aeration" phase).
Holiday mode	Aeration is activated, the system is aerated at intervals, no cleaning cycles are undertaken.
Remaining: XXX.XX min	Display showing time remaining.

## 4. Control unit

### 4.6 Operating the control unit

You can start various queries when in automatic mode.

Pressing **Set** takes you to the first operating level. Now you can call up the individual queries by pressing the two arrow keys **▲▼** and **◀▶** followed by **Set**:

Display KL24plus	Meaning
Operating mode Remaining time	Time remaining in current operating phase
Operating hours counter reading	Operating hours display for individual valves and compressor
Manual mode function	Manual activation of valves
Date time	Current time, day and date. Can be set by pressing SET
Holiday mode set date	Set holiday mode (max. 90 days)
Read out old faults	Operational faults are saved here and can be read out. Press <b>Set</b> to switch between the error message and the associated date
Display settings	The current settings can be viewed using the arrow keys
Action code	For specialists
Enter service menu code	For specialists

#### 4.6.1 Operating hours query

Press the **Set** key. Screen shows:

Operating hours

By again pressing **Set**, the operating hours can be called up for valves, compressor and house pump in turn using the arrow keys **▲▼** and **◀▶**.

Pressing **Esc** once takes you back to the "Operating hours" display.



→ **Note:** If no key is pressed for 10 minutes, normal mode engages automatically.

## 4. Control unit

### 4.6.2 Manually controlling the valves and cabinet fan using "Manual mode"

Press **Set**, then press the arrow key  until the following appears on screen:



Manual mode  
function

Manual mode can now be set for all functions by again pressing **Set** and using the arrow keys   to make the relevant selection.

Taking the example of valve 1, the screen now shows:

Manual mode  
Valve1: OFF

By selecting "1" for "ON" and "0" for "OFF", valve 1 can be activated and deactivated in manual mode.

You can proceed in the same way with the other valves. The valves are selected with the arrow keys   as described above.

Pressing the **Esc** key once takes you back to the maintenance level. And pressing again restores automatic mode.



→ **Note:** Each valve should run for at least 5 seconds when testing because it takes some time to monitor the power consumption of valves before any faults are detected. After the valves, the cabinet fan (if fitted) can also be activated and checked.



## 4. Control unit

### 4.6.3 Setting date/time

Press **Set**, then press the arrow keys until the following appears on screen (example):

20:15:56  
2014-12-19 Mo

By pressing **Set** you can set the time and date using the arrow keys  . To confirm each change, you must press **Set**.

Pressing  once takes you back on to holiday mode. Pressing  takes you back to manual mode.

→ **Note:** The system's time and date **MUST** be set correctly to ensure accurate recording of operating hours and any malfunctions that may occur. The built-in clock has a maximum deviation of 5 minutes per year. There is no automatic switchover from summer to winter time. If no key is pressed for 10 minutes, normal mode engages automatically.

### 4.6.4 Setting holiday mode

→ **Note:** The wastewater treatment system has a reduced operation when in holiday mode. This mode should only be used if no wastewater will be fed into the wastewater treatment system during the selected period. Wastewater which does enter the system during holiday mode is not cleaned. Holiday mode is automatically activated and deactivated on the dates entered.



Press **Set**, then press the arrow keys   until the following appears on screen:

Holiday  
set date

The input of holiday data is released by again pressing **Set**:

**Start of holiday:**

Holiday  
Beg.: 21-05-2007

Pressing   enters the year, month and day in the format YY-MM-DD. **Set** should be pressed each time a year, month of day is entered.

**End of holiday:**

Press the **Set** key again and enter the end date for holiday mode using the numerical keys:

Holiday  
end.: 21-05-2007

## 4. Control unit

Pressing the **Set** key saves the input of data for holiday mode and exits this function.

→ **Note:** Holiday mode can be set for a maximum of 90 days.  
If no key is pressed for 2 minutes, normal mode engages automatically without the date just entered being saved.

### 4.6.5 Reading out errors – old faults

The control unit saves fault messages and the operation of valves using "Manual mode" in what is known as a logbook. This function can be used to call up previous fault messages with time and date. The individual messages can be called up using the arrow keys. The menu item can be exited using **Esc**.

→ **Note:** 128 fault messages can be saved. Once this figure is reached, each new message overwrites the oldest one. The memory can be cleared by a maintenance specialist in the service level using the "Clear logbook" command.

### 4.6.6 Displaying settings

The current control unit settings can be viewed under this menu item. These settings cannot be changed. This menu item is used to analyse the settings without changing them.

### 4.6.7 Service menu

Operating parameters can be changed in the Service menu. Access is protected by a code. This second maintenance level is reserved for qualified staff!

## 4.7 Changing fuses

The control unit has two interchangeable fuses. These are located on the rear of the control unit. De-energise the control unit before changing the fuses.

Fuses used:

Microfuse	KL24plus control unit
F1 supply	6.3 A, slow blow
Consumer F2	2 A, slow blow

## 4.8 Function of the power cut detector

The control unit is equipped with a power cut detector, which is powered via an integrated emergency power supply (buffer). Upon delivery, the emergency power supply is flat. It charges when the control unit is switched on. In the event of a power cut, the charge of one emergency power supply for indicating the power cut will last around 12 hours. If the emergency power supply is not required in response to power cuts, it is prevented from discharging by a switching circuit.

**Important:** In the event of mains failure, the time / date setting is powered for around 10 days by an extra buffer. All saved data, such as operating hours, program settings etc., is retained. If the time and date are not set, weekly operating hours for the units are no longer saved. Error messages occurring in the future are saved with the wrong date.



## 4. Control unit

If the system is disconnected from the mains (e.g. due to a power cut, should the internal fuse blow or by disconnecting from the socket), the indicator issues an acoustic and optical signal in turn regardless of the cause. There is a 5-second delay before the device responds to a mains failure. This prevents brief interrupts, which often occur e.g. during a storm but do not impact on the wastewater treatment system's overall function, from being indicated unnecessarily.

- After the 5-second delay, there is an intermittent beep with a red flashing signal. Five flashing signals and one beep repeat at intervals of 5 seconds for around 12 hours (if the emergency power supply is fully charged).
- The device cannot be switched off when in this state.

When the mains voltage is restored, the device is returned to the monitoring status and the control unit continues from where it left off without any keys having to be pressed. The fault message disappears automatically. If the emergency power supply is flat, the device restarts with a cycle pause.



Power cut

→ **Please note:** If the system is disconnected from the mains for more than 24 hours, the system will be unable to clean the wastewater properly if at all. **Never switch off system** (the only exceptions are if maintaining system parts and in the case of system faults restricting function)

## 5. Start-up

### 5. Start-up

When starting up, the functionality of the small wastewater treatment system is checked by means of a test run. The start-up also includes setting the control unit and instructing the operator.

#### 5.1 Preparations

Before starting up, the following should be ensured for correct operation:

- The switch cabinet and installed parts must not be damaged in any way.
- The connections (inlet and outlet) should be established correctly (no mistakes).
- Lines (air hoses) must be routed and used in the empty pipe as specified.
- The aeration and ventilation function must be checked (smoke cartridge test)
- All installed parts (aeration, lifter and sampling tank) must be checked.
- The switch cabinet must be installed and the electrical connection established.
- The tank's seal integrity should be checked.

#### 5.2 Test run

The system must be filled with water for the test run. The system must be filled to at least 10 cm above the minimum water level so that the lifter's intake connection is covered with water.

The test run is undertaken by the system's control unit. This requires the system to be switched on after filling via the two pin plug.

The system is now ready and runs fully automatically.

<b>System test</b>	When the control unit is switched on, a system test is performed automatically. The system is powered up and the serial number displayed.
<b>System test set time</b>	A note indicating that the time should be set then appears. This note only appears during the first system test. If the control unit was previously switched on before the first start-up, this note does not appear.
<b>HH:MM:SS</b> <b>2013-31-01 Mo</b>	Press <b>Set</b> , then press the arrow keys <b>◀ ▶</b> until the "Time / date" screen appears. Again pressing <b>Set</b> allows the time and date to now be set in turn using the arrow keys <b>◀ ▶</b> . To confirm each change, you must press <b>Set</b> . Pressing <b>Esc</b> takes you back to the menu.

## 6. Level measurement

### 6. Level measurement

The control units are fitted with an integrated pressure sensor as standard. This can establish the level by means of the aeration unit (membrane aerator) secured to the base of the tank.

This level measurement is mainly used:

1. to save power when the wastewater infeed is low (underload detection)
2. to prevent sludge from leaking in the event of overflows (overload detection)

When supplied, this function is deactivated so during your start-up the system runs in automatic mode regardless of utilisation - the amount of wastewater flowing in.

#### 6.1 Function

The water level is measured at adjustable intervals at the start of a cleaning cycle by means of the pressure in the membrane aerator. If the level in the tank exceeds a previously set level ("Level measurement" in service level), the system starts a cleaning cycle. If the set level is not reached, the system automatically goes into cycle pause for the set interval. Only enough oxygen to maintain the biological components is then pumped into the system. The water level continues to be measured during the cycle pause at set intervals. Should sufficient wastewater have again flowed into the system after a certain time, the control unit switches to the normal cleaning cycle once the set level is reached.

#### 6.2 Activation of level measurement

The tank must be filled with water up to the level at which a cleaning cycle is triggered. This level depends on the geometry of the tank and the number of connected inhabitants.

The recommended levels above the minimum water level are stated in the table below for the plastic tanks of the Carat.

→ **Note** Calibration has to be run in order to activate the level measurement. Calibration should be undertaken at least once a year during all maintenance interventions because the pressure at the aeration's membrane may change during operation.

Table 1: Recommended setting for *levels*:

	Carat			
Type	2700	3750	4800	6500
H [cm]	100	115	130	155

## 6. Level measurement

### 1st step: Calibrating the pressure sensor

It is absolutely essential that the sensor is calibrated for first starting up. Please carefully work through the following points in order:

<b>Service menu</b>	Go to "Service code", press the <b>Set</b> key and enter the following code when prompted to do so: 9 9 9 9
<b>Calibrate? No</b>	Use the arrow keys <b>▲ ▼</b> to select "Calibrate Yes" and confirm with the <b>Set</b> key. Calibration then starts automatically.
<b>Measurement un- derway</b>	3 measurement processes are undertaken automatically
<b>Current level input: 000 cm</b>	Enter the current level as measured with rule (measured from base of tank to surface of water) and confirm with <b>Set</b> .
<b>Save? xxx cm No</b>	The measurement now entered is displayed again. Use the arrow keys <b>▲ ▼</b> to select "Save yes" and confirm with the <b>Set</b> key. The calibration is complete and you can exit this menu with the <b>Esc</b> key.

### 2nd step: Setting the control parameters

It is absolutely essential that the control parameters for the level measurement are set for the system to function correctly. Please carefully work through the following points in order:

<b>Service menu</b>	Go to "Service menu", press the <b>Set</b> key and enter the general service code X.X.X. when prompted to do so.
<b>Level measurement</b>	Use the arrow keys <b>▲ ▼</b> to select "Level measurement" and confirm with the <b>Set</b> key.
<b>Level start from: 000 cm</b>	Enter the water level from which a cleaning cycle is to start. Confirm this with the <b>Set</b> key.
<b>Overflow warning from: 000 cm</b>	If 000 cm is saved, this warning message remains <i>deactivated</i> .
<b>Measurement inter- val 04 h</b>	The measurement interval of the level measurement is changed hourly using the arrow keys <b>▲ ▼</b> . The set measurement interval can be confirmed using the <b>Set</b> key. This menu item has a default setting which can usually be retained.

To activate the overflow warning, you need to measure the height between the tank base and the bottom edge of the emergency overflow on the sampling tank. The level of the overflow warning should be around 5 to 10 cm below the emergency discharge.

This level then has to be entered under "Warning overflow" using the arrow keys **▲ ▼** and confirmed with the **Set** key.

If 000 cm is saved, the overflow warning message is deactivated.

## 6. Level measurement

### 3rd step: Function check

The level measurement can now also be manually activated in manual operation for checking purposes.

This requires the level measurement to be activated under Manual mode using the **Set** key. The control unit automatically takes a measurement once switched on. After the measurement is complete, the measured level appears in the display.

## 7. Operation and maintenance

### 7. Operation and maintenance

This wastewater treatment system is a fully aerated system without an anaerobic pre-treatment stage. It is therefore absolutely essential that the control unit and compressor are not switched off – other than for maintenance purposes by specialist staff.

#### 7.1 Operating instructions

Basically only substances with the characteristics of domestic wastewater may enter the system.

Biocides, toxic substances or substances which are not biocompatible or biodegradable must not enter the system because they cause biological process problems. The following are not permitted:

- rainwater from roofs and yards
- infiltration water (e.g. drainage water)
- liquid or solid residue from keeping animals
- commercial or agricultural wastewater, unless it is comparable to domestic wastewater
- chemicals, pharmaceuticals, mineral oils, solvents
- cooling water
- solids in the form of food waste, plastics and hygiene articles, coffee filters, bottle tops and other domestic items
- milk and milk products
- water discharged from swimming pools
- large volumes of blood

If discharging larger volumes of grease or plant-based oils, we would recommend pre-cleaning the wastewater containing the greases/oils in a grease separator upstream of the wastewater treatment system (caution: faeces must not be allowed to enter the grease separator!).

The table below contains a list of substances which must not be disposed of in the wastewater treatment system:

<b>Solids or liquids which should not be disposed of via the sink or toilet:</b>	<b>Why not:</b>	<b>Correct disposal:</b>
<b>Ash</b>	Does not break down	Dustbin
<b>Chemicals</b>	Contaminate the wastewater	Collection points
<b>Disinfectants</b>	Kill bacteria	Do not use
<b>Paints</b>	Contaminate the wastewater	Local collection point
<b>Chip fat</b>	Is deposited in pipes and causes blockages	Dustbin
<b>Adhesive plaster</b>	Blocks the pipes	Dustbin
<b>Cigarette butts</b>	Are deposited in the system	Dustbin
<b>Condoms</b>	Blockages	Dustbin
<b>Corks</b>	Are deposited in the system	Dustbin
<b>Medicines</b>	Contaminate the wastewater	Collection points, pharmacies
<b>Engine oil</b>	Contaminate the wastewater	Collection points, service stations
<b>Waste containing oil</b>	Contaminate the wastewater	Collection points, service stations
<b>Plant protection agents</b>	Contaminate the wastewater	Local collection point

## 7. Operation and maintenance

<b>Solids or liquids which should not be disposed of via the sink or toilet:</b>	<b>Why not:</b>	<b>Correct disposal:</b>
<b>Paintbrush cleaners</b>	Contaminate the wastewater	Local collection point
<b>Cleaning agents, except chlorine-free products (environmentally sound)</b>	Contaminate the wastewater, corrode piping and seals	Local collection point
<b>Razor blades</b>	Risk of injury to staff in the sewage system and treatment plant	Dustbin
<b>Pipe cleaners</b>	Corrode piping and seals, contaminate the wastewater	Local collection point
<b>Pesticides</b>	Contaminate the wastewater	Local collection point
<b>Panty liners</b>	Cause blockages, non-degradable plastic films blight watercourses	Dustbin
<b>Cooking oil</b>	Cause deposits and pipe blockages	Local collection points
<b>Food waste</b>	Cause blockages, attract rats	Dustbin
<b>Wallpaper paste</b>	Causes blockages	Local collection point
<b>Textiles (e.g. nylon tights, cleaning cloths, handkerchiefs etc.)</b>	Block pipes, may paralyse a pump station	Used textiles collection point
<b>Thinner</b>	Contaminates the wastewater	Local collection point
<b>Bird sand, cat litter</b>	Cause deposits and pipe blockages	Dustbin
<b>Cotton buds</b>	Block the system	Dustbin
<b>Toilet blocks</b>	Contaminate the wastewater	Do not use
<b>Nappies</b>	Block the pipes	Dustbin
<b>Cement water</b>	Is deposited, results in production of concrete	Contact specialist company

## 7. Operation and maintenance

### 7.2 Maintenance by a maintenance specialist

The maintenance should be undertaken by a specialist company (experts)<sup>1</sup> at regular intervals (every 6 months). The intervals and work defined by the local water authority in the licence issued under water law also apply. The system owner should take out a maintenance contract with a qualified specialist for this work.

**Note** During retrofitting or any work related to maintenance on the electrical parts of the system, the control cabinet must be de-energised.

Maintenance should include the following:

- Inspection of the operating log to check for correct operation (nominal/actual comparison)
- **Check the air filter of the air compressor and the supply/exhaust air openings on the control cabinet**
- **Air compressor maintenance according to details provided by manufacturer.**
- Function check on mechanical, electro-technical and other system parts key to operation, such as aerator, lifter, control unit, valves
- **Calibration of the level measurement**
- Inspection of sludge height If necessary, the operator must arrange for the sludge to be removed
- Carry out general cleaning work, e.g. remove deposits
- Check the structural condition of the system
- Check sufficient aeration and ventilation
- Analysis of the aeration basin:
  - Even aeration pattern (bubbles)
  - Oxygen concentration ( $O_2/l > 2 \text{ mg}$ ), if necessary adapt the compressor operating times
  - Sludge as proportion of volume SV30 (**if the sludge makes up more than 900 ml/l, sludge removal is required**)

The maintenance work undertaken, any damage found, repairs undertaken and other information should be summarised in a maintenance report by the maintenance company. A suitable template is provided in the Annex. Anything established during the analyses should also be documented in this report. The system operator should be given the maintenance report so that it can be passed to the responsible authorities if demanded. The maintenance report should be attached to the operating manual. Please keep the operating log in a place where it can be easily accessed.

**Note:** System failures resulting from insufficient maintenance (e.g. of the compressor) will not be covered by free replacement under warranty.

---

<sup>1</sup> Specialist companies are those not affiliated to an operator, whose staff (specialists) are suitably qualified to operate and maintain small wastewater treatment systems through their professional training and from having received relevant qualification measures.



## 7. Operation and maintenance

### 7.3 Determination of the sludge removal

**Definition:**

A settlement sample should be taken at the maintenance intervals to determine whether the wastewater treatment system requires sludge removal. The SV30 (VS) is measured for this settlement sample. The SV30 is the volume of sludge that 1000 ml of aerated sludge absorbs after a settlement period of 30 minutes. It is a measurement of the amount of sludge present in the wastewater treatment system.

Determination of the sludge volume is regulated in DIN EN 14702-1.

If the sludge volume is high (> 250 ml/l), the values of an undiluted SV30 measurement according to the standard are not representative.

Reason: The settlement process in the comparatively narrow measuring cylinder is different because the walls of the vessel and interactions of individual flakes interfere with one another.

A diluted sample should therefore be measured for higher volumes of sludge (> 250 ml/l). Another sample with discharge water must be diluted for this purpose, taking water from the sample or clear water excess. The volume ratio may be 1+1, 1+2 or 1+3 and may be multiplied by the dilution factor of 2, 3 or 4. The diluted sample in which the value first falls below 250 ml/l is used to determine the sludge volume.

**Implementation (recommendation):**

1. Series of measurements:

The 1st measurement cylinder is filled up to the 1000 ml mark with the sludge sample. This sample is the undiluted sludge volume. If  $SV30 < 250$  ml/l, this value is representative.

At the same time, a diluted sample is placed in the 2nd measurement cylinder. We recommend diluting to a ratio of 1+2 (330 ml sludge and 670 ml discharge). The value read off is then multiplied by the dilution factor of 3 (see table below).

2. Series of measurements:

If the sludge volumes in the two measurement cylinders of the 1st series of measurements > 250 ml/l, the measurement should be repeated with the 1+3 dilution.

Sludge removal is needed as soon as the results of both the diluted and undiluted measurement produce a SV30 of > 700 ml/l.

The table below can be used to assess the SV30 measurement.

Vers. no.	Measurement cylinder filled with		Reading, diluted ml/l	EVALUATION			
	Aerated sludge ml/l	Discharge ml/l		Dilution	Dil. factor f	SV30 ml/l	SV30 entry ml/l
e.g.	500	500	225	$500 + 500 = 1+1$	2	$225 \times 2 = 450$	450 ( $225 \times 2$ )
e.g.	330	670	210	$330 + 670 = 1+2$	3	$210 \times 3 = 630$	630 ( $210 \times 3$ )

**Table: Evaluation for undiluted SV30 > 250 ml/l**

## 7. Operation and maintenance

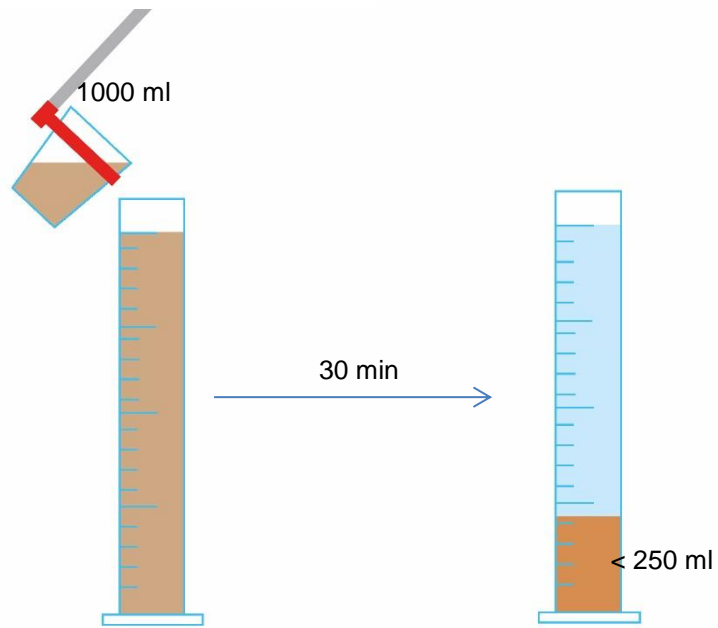

Figure 7: Sludge volume measurement with undiluted aerated sludge sample

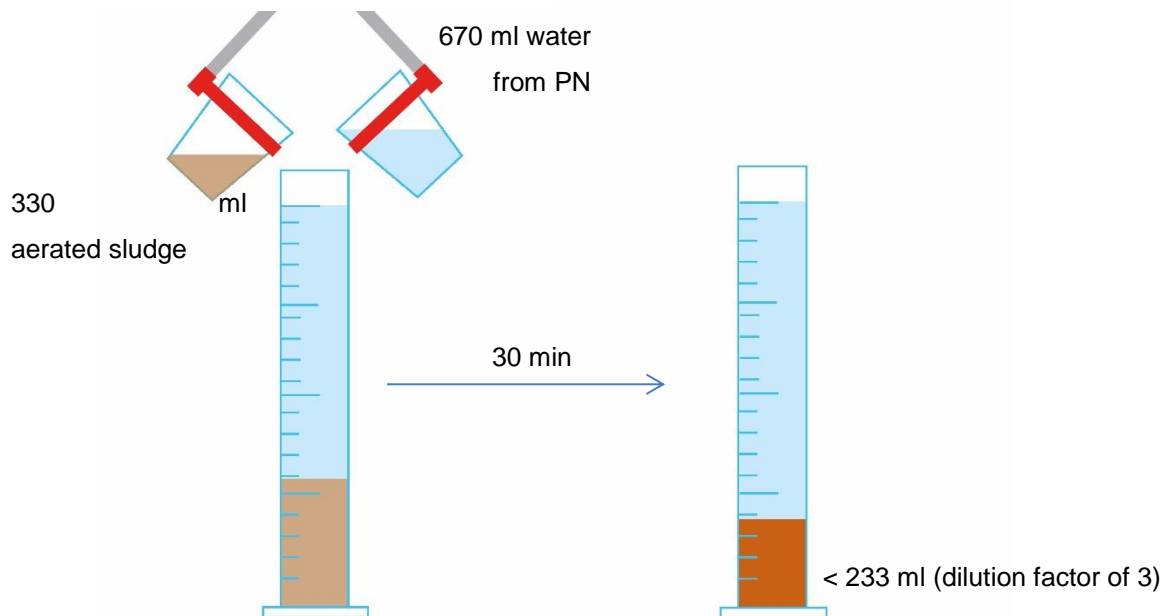

Figure 8: Sludge volume measurement with 1+2 diluted aerated sludge sample

## 7. Operation and maintenance

### 7.4 Sludge removal instructions

Removing sludge from the wastewater treatment system should be carried out according to the following points:

1. Remove the cover
2. Remove the deposits on the water surface and on all visible surfaces (baffle, sample container, siphon)
3. Wash down the visible surfaces
4. Insert the suction hose into the wastewater treatment tank until it reaches the floor  
**(CAUTION: air admittance valves on the ground must not be damaged!)**

Aspirate until about 30 cm of wastewater and sludge remain in the wastewater treatment system

## 8. Fault messages and rectification

### 8. Fault messages and rectification

Technical system operation faults (failure of a unit) are indicated on the control unit display.

#### 8.1 Fault message on display

- Fault message as text on the LCD,
- Operating control light flashes red.

Display LCD	Possible cause	Corrective action
KL24plus		
No display, no light	<ul style="list-style-type: none"> <li>• Power is disconnected</li> </ul>	<ul style="list-style-type: none"> <li>• Check the power supply to the plant and controller</li> <li>• Check the microfuse F1 on the supply line</li> <li>• Check the position of the maintenance switch (position 1)</li> </ul> <p>if the buffer is empty, a power failure will be indicated neither acoustically nor visually.</p>
No display, light is green		<ul style="list-style-type: none"> <li>• Switch off the plant and turn it back on after 10 second.</li> </ul>
No/weak display	<ul style="list-style-type: none"> <li>• Contrast is set incorrectly</li> </ul>	<ul style="list-style-type: none"> <li>• Hold down ESC key and adjust contrast, using the arrow keys.</li> </ul>
Set the clock	<ul style="list-style-type: none"> <li>• Internal clock/date not set</li> </ul>	<ul style="list-style-type: none"> <li>• Make settings in the menu item Date and Time</li> </ul>
**Fault** Com. Fault	<ul style="list-style-type: none"> <li>• Compressor is not working/will not power on</li> </ul>	<ul style="list-style-type: none"> <li>• Check the main fuse F1</li> <li>• Check the compressor in manual mode</li> </ul>
**Fault** Valve 1	<ul style="list-style-type: none"> <li>• Valve does not operate</li> <li>• Blown fuse</li> <li>• Winding defective</li> <li>• Valve jammed due to obstruction</li> <li>• Cable break</li> </ul>	<ul style="list-style-type: none"> <li>• Check the valve in manual mode</li> <li>• Check the microfuse of the consumers F2</li> <li>• Check the valve for possible smoke residue</li> <li>• Unscrew the valve from the metal bar, check it for dirt, and remove dirt (see Maintenance Instructions in the Appendix).</li> </ul>
**Fault** Valve 2		
**Fault** Valve 3		
**Fault** Valve 4		
**Fault** UV module	<ul style="list-style-type: none"> <li>• UV module does not work</li> </ul>	<ul style="list-style-type: none"> <li>• Check the UV module and the remaining lamp life</li> </ul>
**Fault** min fill level	<ul style="list-style-type: none"> <li>• Compressed air line leak between controller and charging lifter, e.g., due to loose hose</li> </ul>	<ul style="list-style-type: none"> <li>• Check hose for leaks</li> </ul>
Warning Backwater	<ul style="list-style-type: none"> <li>• Water level is too high in chamber 1</li> <li>• Compressed air line clogged, e.g. due to kinked hose</li> </ul>	<ul style="list-style-type: none"> <li>• See Point -</li> <li>• Check hose for kinks</li> </ul>
Temperature max	<ul style="list-style-type: none"> <li>• Temperature sensor not plugged in</li> <li>• Cabinet fan is not working</li> <li>• Filters dirty in the cabinet and the compressor</li> <li>• Direct sunlight on the cabinet</li> <li>• Temperatures for turning on the cooling fan and the maximum temperature that are en-</li> </ul>	<ul style="list-style-type: none"> <li>• Plug in temperature sensor on back of controller</li> <li>• Check the function of the cabinet fan</li> <li>• Check air filter in the cabinet</li> <li>• Shade location</li> <li>• Provide cool ventilation</li> <li>• Check air filter in the air compressor</li> <li>• Check air compressor in manual mode</li> <li>• Have maintenance company check set temperatures</li> <li>• Replace temperature sensor</li> </ul>

## 8. Fault messages and rectification

Display LCD	Possible cause	Corrective action
KL24plus		
	<p>tered in the Service menu are too high</p> <ul style="list-style-type: none"> <li>• Air compressor defective</li> <li>• Temperature sensor defective</li> </ul>	
<b>**Fault**</b> Temp Sensor	<ul style="list-style-type: none"> <li>• Temperature sensor is missing</li> <li>• Temperature sensor is not fully plugged into the socket</li> <li>• Temperature sensor defective</li> </ul>	<ul style="list-style-type: none"> <li>• Replace sensor</li> <li>• Ensure secure connection between controller and temperature sensor. Then power off controller for 10 sec. and switch it back on. Check whether a temp sensor fault message is displayed.</li> </ul>
<b>**Fault**</b> Power failure	<ul style="list-style-type: none"> <li>• Power failure</li> <li>• Plant switched off via maintenance switch</li> <li>• No voltage on the switch cabinet</li> <li>• FI fuse has blown</li> </ul>	<ul style="list-style-type: none"> <li>• Wait for power to return</li> <li>• Switch plant on via maintenance switch</li> <li>• Check supply to the switch cabinet</li> <li>• Locate cause for triggering the RCCB and correct it (possible cause: solenoid valve defective).</li> </ul>
<b>**Fault**</b> Modem	<ul style="list-style-type: none"> <li>• Batteries in the module are not yet fully charged</li> <li>• Modem has no mains voltage</li> <li>• No SIM card inserted in the modem</li> <li>• SIM card is not registered to the network</li> </ul>	<ul style="list-style-type: none"> <li>• Wait 5 minutes until batteries are fully charged</li> <li>• Connect modem to power</li> <li>• Insert SIM card in the modem</li> <li>• Wait until the card is registered. Otherwise relocate antenna so that reception is possible.</li> </ul>

## 8. Fault messages and rectification

### 8.2 Unusual water levels - troubleshooting

Observation	Possible cause	Corrective action
The water level in the aeration tank is unusually high.	<ul style="list-style-type: none"> <li>• Plant is running in holiday mode.</li> <li>• Plant is constantly running in cycle pause.</li> <li>• Control settings are incorrect.</li> <li>• The outflow lifter is congested.</li> <li>• The air hose to the outflow lifter is leaking.</li> <li>• Flooding in the receiving water course doesn't allow water to drain from plant.</li> <li>• Controller is defective.</li> </ul>	<ul style="list-style-type: none"> <li>• Ending of holiday mode</li> <li>• Have the controller settings checked by service technician</li> <li>• Have SBR reactor pumped out and clean lifter</li> <li>• Have SBR reactor pumped out and seal hose connections</li> <li>• Wait until flooding subsides,</li> <li>• Contact maintenance company</li> </ul>
The plant emits odours, the treated wastewater is cloudy or discoloured	<ul style="list-style-type: none"> <li>• Too little air is supplied to the plant</li> <li>• One-sided aeration due to defective membrane unit</li> </ul>	<ul style="list-style-type: none"> <li>• Have aeration time increased by service company</li> <li>• Verify aeration diagram, contact maintenance company</li> </ul>
Aeration diagram is one-sided and large, isolated bubbles are rising	<ul style="list-style-type: none"> <li>• Membrane unit defective</li> <li>• Aerator unit is leaking</li> <li>• Aerator unit is not positioned correctly on the bottom</li> </ul>	<ul style="list-style-type: none"> <li>• Contact maintenance company</li> <li>• Contact maintenance company</li> </ul>

### 8.3 Possible faults at the air distributor (valve block)

Observation	Possible cause
Anchor does not pick up.	<ul style="list-style-type: none"> <li>• Supply voltage is interrupted or insufficient.</li> <li>• Motor defective!</li> <li>• Anchor blocked in polluted tube space.</li> </ul>
Valve does not close.	<ul style="list-style-type: none"> <li>• Anchor blocked!</li> <li>• No power supply</li> </ul>
Valve does not open.	<ul style="list-style-type: none"> <li>• Nominal voltage is not present</li> </ul>

Status: 08 / 2018

*Specifications subject to change without notice!*

## 9. EC conformity declaration

### 9. EC conformity declaration

Manufacturer: Otto Graf GmbH  
Carl-Zeiss-Straße 2-6  
DE-79331 Teningen

hereby declares that the **one2clean plus** small wastewater treatment system meets the requirements of the following directives:

**2006/42/EC** Directive of the European Parliament and of the Council of 17 May 2006 on machines and changes to Directive 95/16/EC.

**2006/95/EC** "Directive of the Council relating to electrical equipment designed for use within certain voltage limits"

The following harmonised standards were applied:

**EN 60204-1** Electrical equipment of machines. Part 1: General requirements

**EN ISO 13849-1** Safety of machinery – Safety-related parts of control systems. – Part 1: General principles for design

This EC declaration of conformity ceases to apply if the product is modified without consent.

Teningen, 13/01/2014

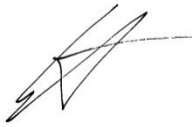

---

Arne Schröder  
(Product management team leader)

### 10. Technical data

#### 10.1 Technical data for control units

Programmable logic microcontroller

- T3,15A fuse (internal)
- Wide-range 100-240 VAC/ 50-60 Hz power supply
- Real-time clock with deviation of 5 min./a, with battery buffer
- Log book, resistant to zero voltage
- Cable failure monitoring compressor by measuring the output currents
- Operating/error message display with LED (green/ red)
- Operating temperature range 0°C ...+55°C
- Permissible temperature range without operation -20°C ... +85°C
- Relative air humidity 10...95 %, no condensation
- Degree of protection IP54
- 14 keys control unit
- Display: Graphic display with 128x32 pixels

Outputs:

- 230 VAC 50 Hz compressor (standard)
- 4 x 24 VDC stepped motors for compressed air flow
- 24 VDC/ < 250 mA metering pump for phosphate precipitation or metering of carbon
- External 24 VDC/ < 26 mA warning light



# 10. Technical data

## 10.2 Circuit diagrams

### 10.2.1 Circuit diagram for KL24plus control unit in EPP cabinet

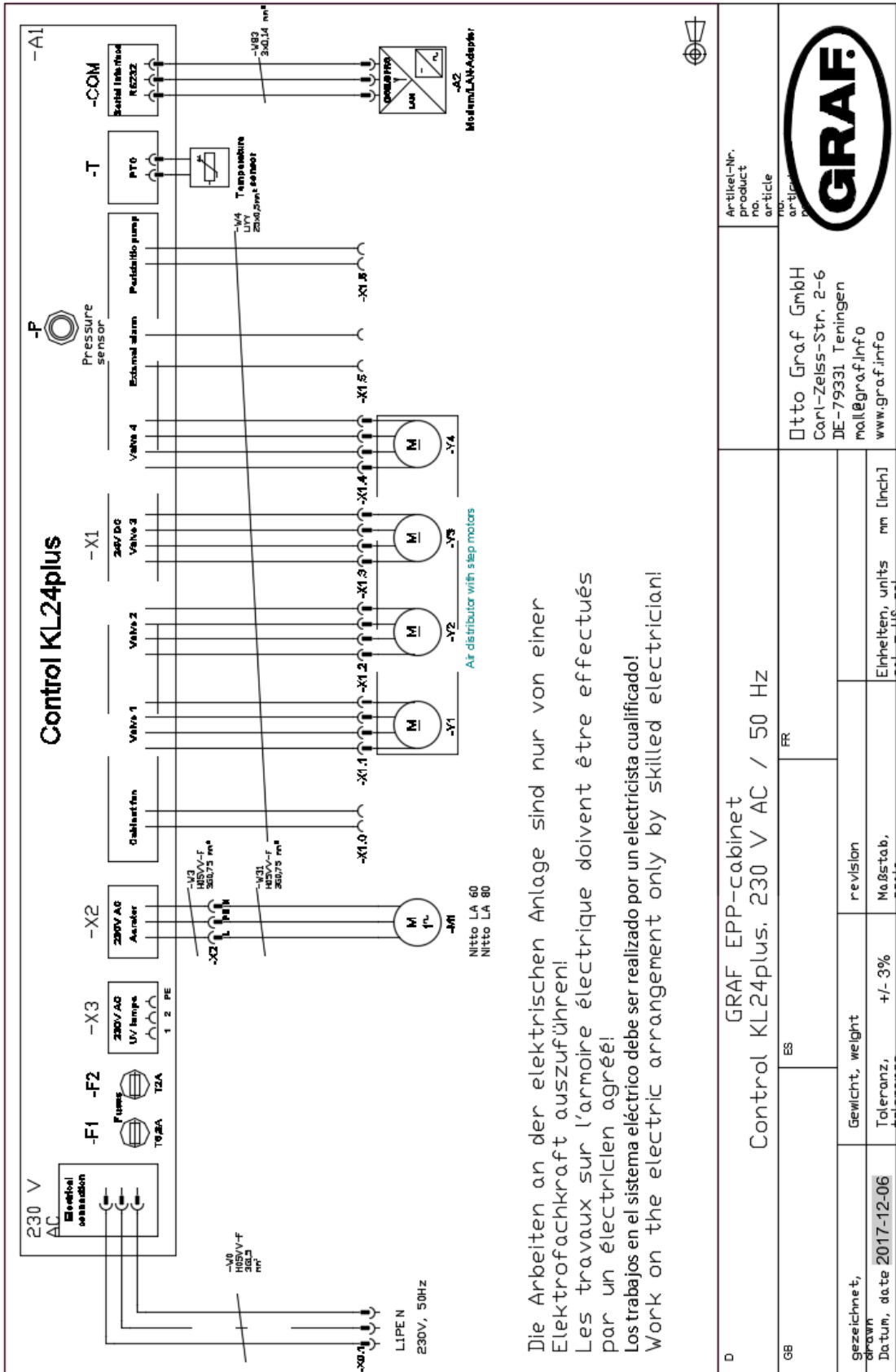







## 12. Maintenance log for GRAF small wastewater treatment systems

### 12. Maintenance log for GRAF small wastewater treatment systems

Location (address): \_\_\_\_\_

Maintenance company: \_\_\_\_\_ Date of maintenance: \_\_\_\_\_

Serial number: \_\_\_\_\_ Order no.: \_\_\_\_\_

System size: \_\_\_\_\_ PE Actual connection \_\_\_\_\_ PE

Operator's name: \_\_\_\_\_ Customer no.: \_\_\_\_\_

1st line of address: \_\_\_\_\_ Tel. no.: \_\_\_\_\_

Town/city, postcode: \_\_\_\_\_ Fax no.: \_\_\_\_\_

Installed by: \_\_\_\_\_ Start-up: \_\_\_\_\_

Will the system process commercial wastewater too?

No

Restaurant without kitchen

Restaurant with kitchen

Other \_\_\_\_\_

Grease separator present, NG \_\_\_\_\_

Emptying needed

Function check of system parts important to operation:

Aeration / valve 1 (blue)

Discharge lifter / valve 2 (black)

Excess sludge lifter / valve 3 (white)

Power cut indicator

Air inlet / aeration:  moderate

intensive, circulation clearly visible

Aerator pattern / aeration:  fine bubbles

even

Comments: \_\_\_\_\_

Sludge accumulator + buffer:

Sludge height: \_\_\_\_\_ cm Floating sludge height: \_\_\_\_\_ cm

The operator should arrange for the cesspit to be emptied.

SBR reactor:

Oxygen concentration: \_\_\_\_\_ mg/l (normally approx. 4-6 mg/l, at least 2 mg/l)

Sludge as proportion of volume: \_\_\_\_\_ ml/l (maximum 700 ml/l)

Comments: \_\_\_\_\_

Control unit: \_\_\_\_\_

Control unit type: \_\_\_\_\_  $\Sigma$ - operating hours: \_\_\_\_\_

Aeration (valve 1): \_\_\_\_\_ Discharge (valve 2): \_\_\_\_\_

Excess sludge reservoir (valve 3): \_\_\_\_\_

## 12. Maintenance log for GRAF small wastewater treatment systems

Comments: \_\_\_\_\_

**Blower:**

Blower type: \_\_\_\_\_  Blower OK  
 Change the slats (slat length: mm): \_\_\_\_\_  Change the membranes  
 Filter change  Cooling fan OK

Comments: \_\_\_\_\_

**Time of sampling:** \_\_\_\_\_ **Date:** \_\_\_\_\_ **Time:** \_\_\_\_\_

Sampling site: \_\_\_\_\_  Sampling shaft  SBR chamber

Sample transport: \_\_\_\_\_  cooled 4°C  frozen

Air temperature:	°C	Water temperature:	°C	
Odour	<input type="checkbox"/> none <input type="checkbox"/> weak <input type="checkbox"/> strong	<input type="checkbox"/> rotten <input type="checkbox"/> earthy		
Colouring	<input type="checkbox"/> none <input type="checkbox"/> weak <input type="checkbox"/> strong	<input type="checkbox"/> beige <input type="checkbox"/> brown		
Cloudiness	<input type="checkbox"/> none <input type="checkbox"/> weak <input type="checkbox"/> strong	<input type="checkbox"/> opaque		
Floating matter	<input type="checkbox"/> none <input type="checkbox"/> a little <input type="checkbox"/> a lot			

Dry substance

Activated sludge \_\_\_\_\_ kg SOL / m<sup>3</sup> P<sub>total</sub> \_\_\_\_\_ ml / l

Substances that can settle \_\_\_\_\_ ml / l pH \_\_\_\_\_

BOD<sub>5</sub> \_\_\_\_\_ ml / l COD \_\_\_\_\_ ml / l

NH<sub>4</sub>-N \_\_\_\_\_ ml / l N<sub>tot</sub> \_\_\_\_\_ ml / l

**Additional comments:**

Operating log available.  Maintenance noted in the log.  
 Programming modified: \_\_\_\_\_  
 Fault rectified: \_\_\_\_\_  
 Additional comments: \_\_\_\_\_  
 \_\_\_\_\_  
 \_\_\_\_\_

**To be arranged by the operator:**

The operator is asked to note the substances which must not enter the system (see operating manual).  
 Pit is overflowing, operator must discharge content.  
 Sludge removal

\_\_\_\_\_  
Date and signature



